

DATASHEET – DIMENSIONS

HYDRAULIC CYLINDERS STANDARD 80/40-xxx

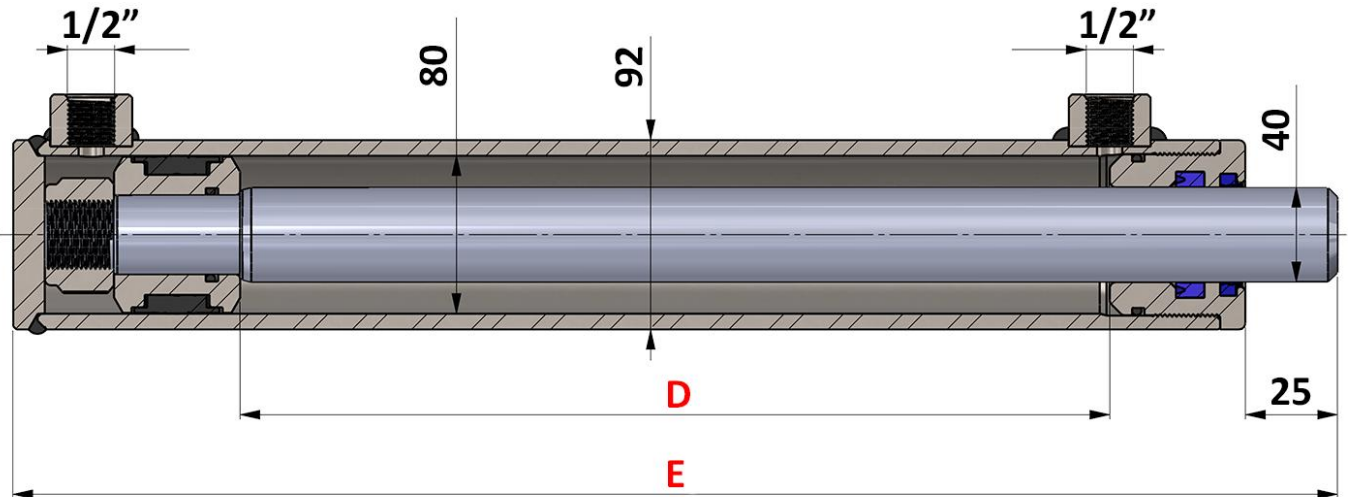

	STANDARD	E	D (stroke)
Code	80/40-xxx	[mm]	
10782	80/40-100	275	100
10783	80/40-150	325	150
10785	80/40-200	375	200
10785	80/40-250	425	250
10786	80/40-300	475	300
10787	80/40-350	525	350
10788	80/40-400	575	400
10789	80/40-450	625	450
10790	80/40-500	675	500
14147	80/40-550	725	550
10791	80/40-600	775	600
10792	80/40-700	875	700
10793	80/40-800	975	800
10794	80/40-900	1075	900
10795	80/40-1000	1175	1000